



SERIES 16

TEMPERATURE/PROCESS CONTROLLER



Instruction Manual

Introduction

Congratulations on your purchase of an Athena® Series 16 Single-Loop Controller. It is designed for ease of use and reliability wherever accurate closed-loop control is required. Your Series 16 has been configured according to your ordering specifications as either a universal process controller or a dedicated temperature controller. In addition, special functions such as a heater break alarm, digital communications, etc., do not require you to make any internal jumper or DIP switch settings.

After following the instructions for installation, simply step through and set your desired parameters using the Series 16's easy menu system. The instrument may then be automatically or manually tuned to your process for optimum setpoint control. A Quick-Start Reference Card is attached to the back of the instruction manual for experienced users of PID controllers. If you still have questions or require any assistance in setting up or operating your controller, please contact your Athena representative or call 1-800-782-6776.

Precautions

After unpacking, inspect the instrument for any physical damage that may have occurred in shipping. Save all packing materials and report any damage to the carrier immediately.

Safety Warning

In addition to presenting a potential fire hazard, high voltage and high temperature can damage equipment and cause severe injury or death. When installing or using this instrument, follow all instructions carefully and **use approved safety controls**. Electrical connections and wiring should be performed only by suitably trained personnel.

Do not locate this instrument where it is subject to excessive shock, vibration, dirt, moisture, oil or other liquids. Safe ambient operating temperature range is 32° to 131° F (0° to 55° C).



NOTES ON CE EMC COMPLIANCE

This unit is compliant with the following standards when properly installed in a grounded metal panel:
EN55011 (CISPR 11), Class B
ENS0082-1

Table of Contents

<i>Installation</i>	
Mounting	1
Wiring	2
<i>Operation</i>	
Notes on Outputs	4
Parameter Menu Organization	6
Notes on Alarms	10
Tuning	17
<i>Special Functions</i>	
Auto/Manual	22
Remote Setpoint Select	22
Process Variable Retransmission	24
Heater Break Alarm	25
Transducer Excitation	26
<i>Digital Communications</i>	27
<i>Recalibration Procedure</i>	34
<i>Error Codes</i>	34
<i>Warranty/Repair Information</i>	35
<i>Technical Specifications</i>	36
<i>Ordering Codes</i>	39

Installation

Measurements between centerlines of panel cutouts are minimum recommended.

Figure 1. Recommended Panel Layout for Multiple Controllers

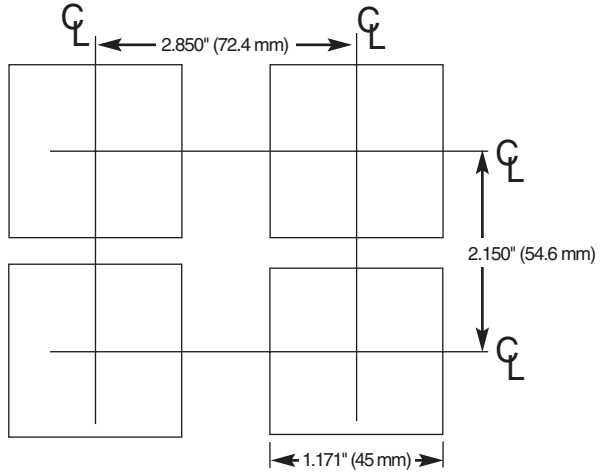
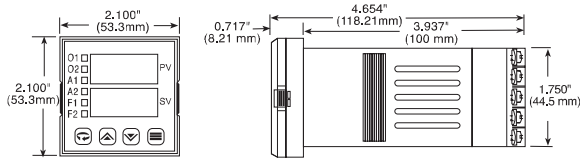

Figure 2. Case Dimensions



Prior to mounting the Series 16 in your panel, make sure that the cutout opening is of the right size, 1.771" x 1.771" (45 mm x 45 mm), and deburred to enable a smooth fit. A minimum of 4" (100 mm) of depth behind the panel is required.

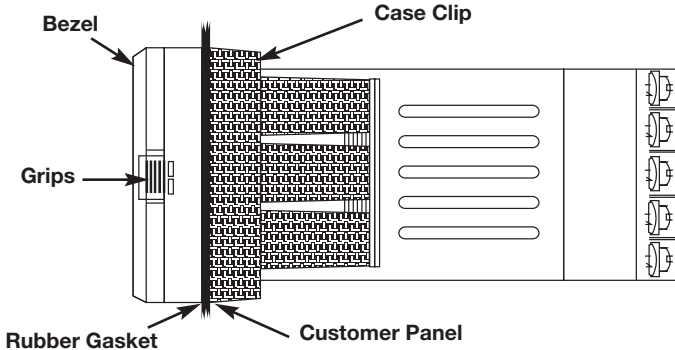

Figure 3. Series 16 Mechanical Components

Sensor Input Connections

Thermocouple circuit resistance should not exceed 100 ohms for rated accuracy; errors will occur at higher resistance values. If shielded thermocouple wire is used, terminate the shield only at panel ground.

Use wire with a resistance no greater than 10 ohms. An error of 0.2° F will result for each additional 10 ohms of resistance encountered. If shielded RTD wire is used, terminate the shield only at panel ground.

Figure 5. Thermocouple Input Wiring

Make sure that you are using the appropriate thermocouple and extension wire. Connect the negative lead (generally colored red in ISA-type thermocouples) to contact #9; connect the positive lead to contact #10. Extension wires must be the same polarity as the thermocouple.

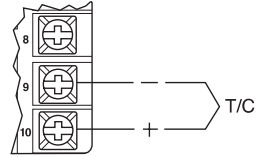
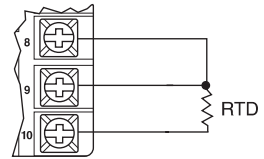
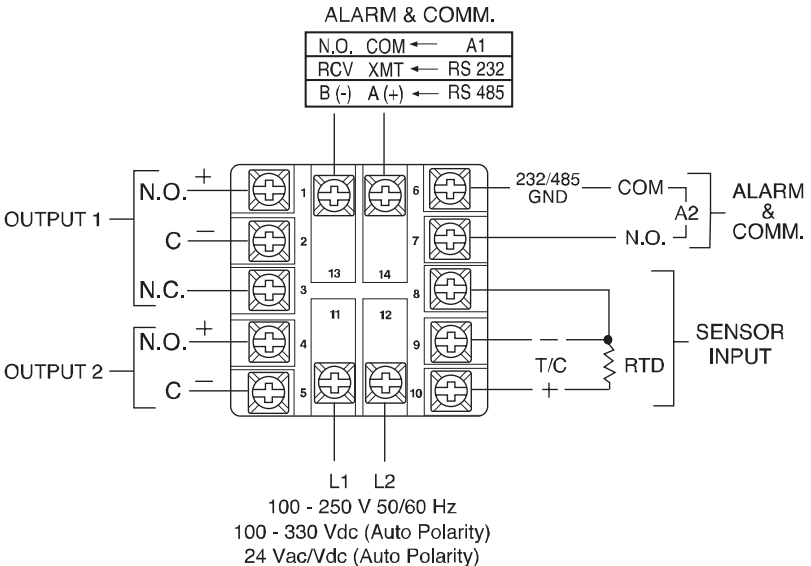

Figure 6. RTD Wiring

The Series 16 accepts input from 2- or 3-wire, 100 ohm platinum resistance temperature detectors (RTDs). Connect 2-wire RTDs to contacts #9 and #10, with a jumper across contacts #8 and #9. Keep leads short and use heavy gauge copper extension wire, if necessary, to minimize lead resistance. For long runs, 3-wire RTDs should be used.



Note: For 2 Wire RTD Jumper 8 & 9



Power Wiring

Figure 7. Process and Linear Input Wiring

Voltage Inputs: Connect the positive voltage input to contact #10; the negative input to contact #8.

mV/Current Inputs: Connect the positive current input to contact #10; the negative input to #9.

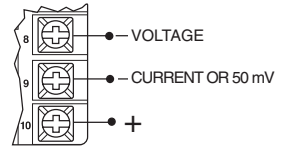

The Series 16 power supply accepts 100 to 250 Vac and 100 to 330 Vdc line power without any switch settings or polarity considerations. All connections should be made in accordance with the National Electrical Code and local regulations, using only NEC Class 1 wiring for all power terminals.

It is advisable, but not necessary, to fuse one leg of the incoming power line, contact #11, with a 2AG, 0.5 amp rated fuse. *Be sure that only instrument power input is fused — not power to the load.*

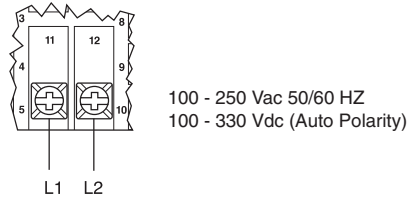

Figure 8. Power Wiring Connection

Operation

Throughout this manual, instructions that pertain solely to the Series 16 process controller are shown in blue.

Athena Series 16 Universal Controller

The Series 16 is a full-function, autotuning PID controller, calibrated and pre-configured for your application requirements, according to the ordering code specified, either as a temperature or linear process controller. (See page 39 for specifications and ordering code).

Just a few easy steps are required before the instrument can be placed into service. After completing the mounting and wiring procedures as previously instructed, set your individual process parameter values by stepping through the Series 16's setup menus, using the simple front-panel keys as instructed. Then, initiate the autotuning sequence as shown (or tune manually).

Notes on Outputs

When you ordered your Series 16 controller, a specific output type was specified, designated as either "B", "E", "F", "S", "T" or "Y". You also had the option of configuring your controller with either one or two output actions. Generally, output 1 is a heat (**reverse-acting**) function and output 2 is a cool (**direct-acting**) function. For best results, follow the recommendations for setting cycle times for the output type supplied with your controller. A brief description of output types follows:

Output Type	Description
B	5A/3A (120/240 Vac) relay, normally open, used for switching resistive loads. If relays or solenoids are to be driven, select the "T" output. If a "B" output is selected, order snubber network 235Z005U01.
E	0-20 mA
F	4-20 mA, full output to load with 500 ohm impedance max. (suppressed).
S	20 Vdc pulsed output for solid-state relays.
T	1 A @ 120/240 Vac , solid-state relay, zero voltage-switched and optically isolated from drive signal. Only resistive loads to may be controlled directly. Larger loads may be controlled using an external contactor.
Y	5A/3A (120/240 Vac) relay, but normally closed (output 2 only).

Operation

Figure 10. Front Panel Controls and Indicators

Output 1

LED indication of Heat cycle (Output 1 action)

Output 2

LED indication of Cool cycle (Output 2 action)

Alarm 1

LED indication of Alarm1 condition

Alarm 2

LED indication of Alarm 2 condition

Function 1

LED indication of Special Function 1

Function 2

LED indication of Special Function 2

After mounting and wiring your Series 16 controller, you are ready to set the parameter values required of your application. Take a moment to familiarize yourself with the unit's front panel controls and indicators.

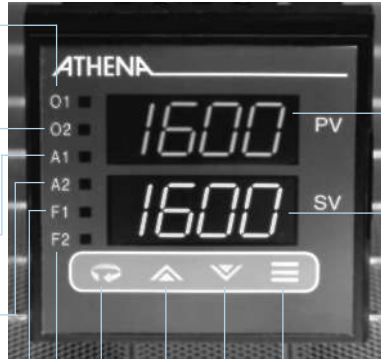

Process Value

Displays measured process temperature in °F or °C or process value in engineering units

Setpoint Value

Displays programmed setpoint temperature in °F or °C or setpoint value in engineering units

Mode Key Used to access Standby, Tune, Run or Manual modes.





Lower Key Used to scroll down through available parameter settings, decrease values or change menu levels (Hold for fast-step progression)

Raise Key Used to scroll up through available parameter settings, increase values or change menu levels (Hold for fast-step progression)

Parameter/Access Key Used to index through parameters or to access Menu Levels

Power On



When power is first applied to the Series 16, both displays and all LED indicators are momentarily illuminated. The Process Value (PV) window then displays [-At-] or [-Ap-] and the Setpoint Value (SV) window displays an initialization code, e.g., [tf06]. The last two digits of this code indicate the software revision supplied with your controller. Please provide this revision number when contacting us regarding your controller. Depending upon whether Setpoint Target Time [SP.tt] is enabled, you may also see this symbol:  or . This means that the controller is ramping up or down to setpoint according to its previously programmed parameters. The default setpoint on initial power up is equal to the process temperature (process value). Before proceeding further, wait until the display has stabilized and then use the Raise  or Lower  keys to enter or adjust your desired Setpoint Value.

Parameter Menu Organization

Your Series 16 controller has five distinct menu levels. This enables quick access to relevant parameters without the need for scrolling through long menus. Menu “05” is used for initial controller configuration and menus “02” and “03” are used for setting or changing parameters. Menus “00” and “01” are used when the controller is in regular unattended operation and are not used for setting parameters. **For safety and security purposes, we recommend placing the controller in menu level “00” or “01” when in regular operation; however, it is not required.**



If you wish to “escape” from parameter selection within these menus at any time, simply press the Mode  key once. A description of the menu hierarchy and a detailed listing of menus and parameters begins on page 15.

Operation



You cannot enter Standby Mode from menu level "00".

Follow the instructions for changing menu levels to select another level.

Standby Mode





When the controller is placed in Standby Mode, outputs are disabled; however, access is permitted to all menu levels and, unless the controller is at Run menu levels "00" or "01", operating parameters may still be changed. Use this mode for tuning the controller. To enter Standby Mode, press and hold the Mode key  for four seconds until the lower window display flashes [StbY]. To exit Standby Mode from Menu Levels "01" to "05", press and hold the Mode  key for four seconds until the lower window display flashes [tUnE]. (If the Damping setting in menu "02" is [OFF], then [HEAt] or [Cool] will be displayed instead of [tUnE]. Press and hold the Mode key for four more seconds until the lower window returns to a steady display of Setpoint Value. (This procedure will not affect tuning). Removing power to the controller will also take the instrument out of Standby Mode.

Accessing Menu Levels

To access menu levels from Standby Mode from menu levels "02" to "05", press the Parameter/Access  key once. From menu levels "00" and "01", press and hold the Parameter/Access  key for approximately 11 seconds until the lower window display alternates between [Ac.Cd] and the menu level number last activated.

Operation

Changing or Displaying Menu Levels

To change menu levels, access the menu level display as instructed in the previous paragraph, then use the Raise  or Lower  key to set the desired menu level number. To display the current menu level setting in menu levels “02” to “05”, from Standby or while adjusting/viewing parameters, press the Parameter/Access  key once. For menu levels “00” and “01”, press and hold the Parameter/Access  key for approximately 11 seconds.





Operation

Because the Series 16's initial configuration affects other menu levels, it is important to set all required parameters in this menu first before accessing other menu levels.

Menu Level Descriptions

Menu “05” (Configuration Setup)

This is the menu level used for specifying initial configuration parameters before the controller is placed in Run mode.

After changing the access code to “05” as instructed in the previous paragraph, press the Parameter/Access  key to step through the various control parameters. Available parameters will flash in the lower window display, alternating with the current value for that parameter. To increase or decrease the value, simply press the appropriate Raise  or Lower  key, then press the  key to step to the next parameter. To exit the menu at any time, press the Mode  key.

Note: When programming in menu level “05”, all outputs are disabled; however, any active alarms will remain active until the alarm condition is removed. New alarm conditions will not be recognized.

Menu “04” (Communications and Calibration Setup)

This menu is used to set up the controller for digital communications and for recalibrating the controller. If your Series 16 controller was ordered with the digital communications option, set these parameters next. To access this menu level, follow the instructions previously given.



Menu “03” (Alarm, Timing and Limit Setup)

In this menu, alarms, cycle times, setpoint target time and limits are established. After changing the access code to “03”, press the Parameter/Access  key to step through the various parameters. To set or change parameter values, follow the instructions given previously.

Menu “02” (Control)

Gain, Rate and Reset parameters are automatically set during autotuning. However, they can be manually adjusted by the operator. To return the controller to the Run mode, change the menu level access code back to “00” or “01” as previously shown.

Menu “01” (Run — Limited Access Mode)

The only parameter that can be changed at this menu level is the Setpoint Value, using the appropriate Raise  or Lower  key. To set or change other parameters, the operator must access another menu level by pressing and holding the Parameter/Access  key for 11 seconds.

Menu “00” (Run — Key Lock Mode)

This menu is automatically active when power is first applied. Both display windows are illuminated; however, access is denied to all parameters. To set or change parameters, the operator must access another menu level as instructed previously.

Notes on Alarms

Either [OUT 1] or [OUT 2] in menu level “05” (but not both) may be configured as an alarm [ALr] if your Series 16 was ordered with a “B”, “S” or “T” type of output module. (With “Y” modules, an alarm may be configured only on [OUT 2]) When one of the two available Outputs is configured as an alarm, the other Output may be used for control .

When the controller is provided with the Dual Alarm option, two independent alarms are automatically enabled for both outputs. **DO NOT USE THE [ALr] SETTINGS FOR [OUT 1] OR [OUT 2]**. Otherwise, follow the regular instructions for configuring the Dual Alarms in menu level “05”.

The Series 16 offers a unique capability that provides for the activation of two software alarms (in addition to the dual alarms) to monitor a total of four possible alarm conditions. To enable these software alarms, set the [OUT 1] and [OUT 2] parameter(s) in menu level “05” to on/off mode [Ht.O], [CL.O] or [On.F]. Set the Setpoint Value to your first alarm point. Switch to menu level “02” and set Spread [C.Spr] [[Spr.2](#)] to the desired deviation value from the first alarm point. Set [H.HYS] and [C.HYS] to 1. Then switch to menu level “03” and set the desired values for the third and fourth alarm points at [ALr 1] and [ALr 2], respectively. Press the Mode  key to resume operation.

Operation

Available Alarm Types [A1.P.d.] [A2.P.d.]

Selectable at menu level "05", as either Process [Pr] or Deviation [dE] and either high or low [A1.HL] or [A2.HL].

Process Alarm: Activates at preset value independent of setpoint. "High" process alarm activates at and above alarm setting. "Low" process alarm activates at and below alarm setting.

Deviation Alarm: Activates at a preset deviation value from setpoint. "High" or "Low" deviation alarm activates above or below setpoint according to the preset deviation value.

Latching Alarms

The Series 16's alarms may also be configured as latching alarms by selecting "LAT" in the [A1.O.P.] or [A2.O.P.] parameter selection at menu level "05".

When a latching alarm has been activated and the alarm condition has been removed, the Mode ≡ key must be pressed to unlatch the alarm.



Figure 11. Series 16 Controller Menu Hierarchy

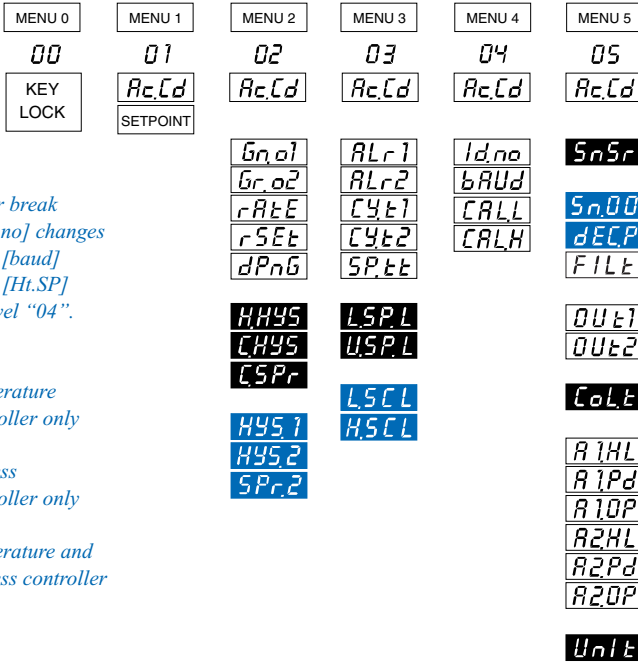

With heater break option, [id.no] changes to [Ht.rd]; [baud] changes to [Ht.SP] in menu level "04".

■ = temperature controller only

■ = process controller only

□ = temperature and process controller

Parameter Descriptions

Series 16 Temperature/Process Controller

Menu "05"

Display	Parameter	Selection	Code
SnSr	Sensor type	Thermocouple:	
		K	c.A
		J	J
		N	n
		R	r
		T	t
		S	S
		Platinel II	PLII
		RTD	P
		RTD (decimal range)	d
		Heat PID	Ht.P
		Heat On/Off	Ht.O
		Alarm	ALr
OUT1	Output 1 action	Cool PID	CL.P
		Cool On/Off	CL.O
		Alarm	ALr
OUT2	Output 2 action	Cool PID	CL.P
		Cool On/Off	CL.O
		Alarm	ALr
SN.00	Input Zero Level	(0-20mA)	U.Su (Unsuppressed)
		(4-20mA)	Su (Suppressed)
Dec.P	Decimal Point		999, 99.9, 9.99
FILt	Digital Filtering		0.1, 1, 10
OUT1	Output 1 action	PID	Pid
		On/Off	On.F
		Alarm	ALr
OUT2	Output 2 action	PID	Pid
		On/Off	ON.F
		Alarm	ALr

The Digital Filtering setting [FILt] on the Series 16 process controller allows the operator to compensate for noise which may cause the last digits of the PV display to become unstable. Sampling rate is not affected. The settings are time constants, in seconds, with 0.1 equivalent to "no filtering."

Parameter Descriptions

CoL.t*	Cooling type	Water Normal	H2o (non-linear output) nor (linear output)
A1.H.L.	Alarm 1 select	Enable	Lo/Hi
A1.P.d.	Alarm 1 type	Process/Deviation	Pr/dE
A1.O.P.	Alarm 1 output	Off/Normal/Latching	OFF/nor/LAT
A2.H.L.	Alarm 2 select	Enable	Lo/Hi
A2.P.d.	Alarm 2 type	Process/Deviation	Pr/dE
A2.O.P.	Alarm 2 output	Off/Normal/Latching	OFF/nor/LAT
Unit	Measurement units	°F or °C	F/C

* For water-cooled extruders, select H2o.

With the Heater Break Alarm option, [Id.no] changes to Heater Current Reading [Ht.rd] (indication only) and [bAUd] changes to Heater Break Alarm Setpoint [Ht.SP] (indication only, either 00-30 A or 00-60 A).

Menu "04"

Display	Parameter	Allowable Values
Id.no	Device ID number (remote communications)	00 to 99
bAUd	Baud, parity and data bit selection	See chart below
CAL.L	Calibration low	Preset at factory
CAL.H	Calibration high	Preset at factory

Display	Available Communications Settings			
	Baud Rate	Parity	Data Bits	Stop Bits
3.o.7	300	odd	7	2
6.o.7	600	odd	7	2
12.o.7	1200	odd	7	2
24.o.7	2400	odd	7	2
3.n.8	300	none	8	1
6.n.8	600	none	8	1
12.n.8	1200	none	8	1
24.n.8	2400	none	8	1

Parameter Descriptions

Setting output cycle time to “00” initiates a 200 ms timebase. A cycle time setting is required for smooth proportional action. Too long a setting will cause proportional ripple; too short will decrease relay contactor life.

When changing thermocouple types, be sure to check/adjust upper and lower setpoint limit values.

Menu “03”

Display

ALr1

ALr2

CY.t1

CY.t2

SP.tt

L.SP.L

U.SP.L

L.SCL

H.SCL

Output Type

B (5A/3A)

E (0-20 mA)

F (4-20 mA)

S (pulsed 20 Vdc)

T (S.S. relay)

Y (5A/3A) N.C.

Parameter

Alarm 1 preset

Alarm 2 preset

(if ordered)

Cycle time output 1

Cycle time output 2

Setpoint target time

(ramp-to-setpoint)

Lower setpoint limit

Upper setpoint limit

Low scale setting

High scale setting

Recommended Setting (seconds)

15 to 120

00

MUST be set to 00

00 to 120

15 to 120

15 to 120 (Output 2 only)

Allowable Values

Dependent on sensor range

Dependent on sensor range

00 to 120 seconds

00 to 120 seconds

Off/1 to 100 minutes



Dependent on sensor range



Dependent on sensor range

-1999 to 9999

-1999 to 9999

Note: Shorter cycle times may be used when driving heater loads directly.

Notes on Setpoint Target Time: The [SP.tt] parameter allows the operator to enter a time delay for the process to reach setpoint temperature (ramp to setpoint), from disabled [OFF] or 1 to 100 minutes. When enabled, the ramp sequence starts on power-up. The ramp-to-setpoint feature will also be initiated whenever a new setpoint target time is entered AND the Setpoint Value is 5° F or more from the current process temperature. In operation, the controller's lower window display will flash  or  to indicate that it is “ramping” up or down to setpoint. The Setpoint Value cannot be changed during this procedure. After it is finished, the operator can adjust the setpoint temperature to the desired value.

While in ramp startup, the ramp-to-setpoint mode can be aborted and the controller returned to regular operation by pressing the Parameter/Access  key until parameters are displayed and then pressing the Mode  key once.

Parameter Descriptions

Setting Rate (Derivative) or Reset (Integral) to [00] disables that aspect of PID control. The ratio for non-zero settings of rate-to-reset is limited to a minimum of 1:4, i.e., Reset value cannot be set any lower than four times Rate.

The parameters of Heat Hysteresis, Cool Hysteresis and Cool Spread are only available when Output 1 and/or Output 2 are set to on/off mode [Ht.O] or [CL.O]. They replace Gain Output 1 and Gain Ratio Output 2, respectively.

Menu "02"

Display	Parameter	Allowable Values
Gn.o1	Gain Output 1 (PID heat gain)	00 to 400 (This value may exceed 400 during autotuning.)
Gr.o2	Gain Ratio Output 2 (PID cool gain ratio)	0.0 to 2.0
H.HYS	Heat Hysteresis	01 to 100°
C.HYS	Cool Hysteresis	01 to 100°
HYS1	Output 1 Hysteresis	1 to 100 units
HYS2	Output 2 Hysteresis	1 to 100 units
SPr.2	Spread Adjustment, Output 2	0 to 100 units
C.SPr	Cool Spread	0 to 100°
rAtE	PID rate	00 to 900 seconds
rSEt	PID reset	00 to 3600 seconds
dPNg	Damping (see notes)	Lo, nL, Hi, Off

Notes on Damping: The damping parameter is an autotune feature that enables more precise control of setpoint overshoot during recovery from process upsets in which thermal or transfer lag is a factor. See Figure 12. Use the correct setting prior to autotuning to compensate for power and load/sensor coupling characteristics.

Lo = Fast recovery with slight overshoot. For single-lag processes.
Ex. Adequate power and excellent load/sensor coupling.

nL = Normal recovery with no overshoot. For two-lag processes.
Ex. Properly sized heaters or components and good load/sensor coupling.

Hi = Slow recovery with no overshoot. For three-lag processes.
Ex. Overpowered with multiple lags. Poor load/sensor coupling.

Off = Autotune disabled; manual output control.

Figure 12. Typical Lag Processes

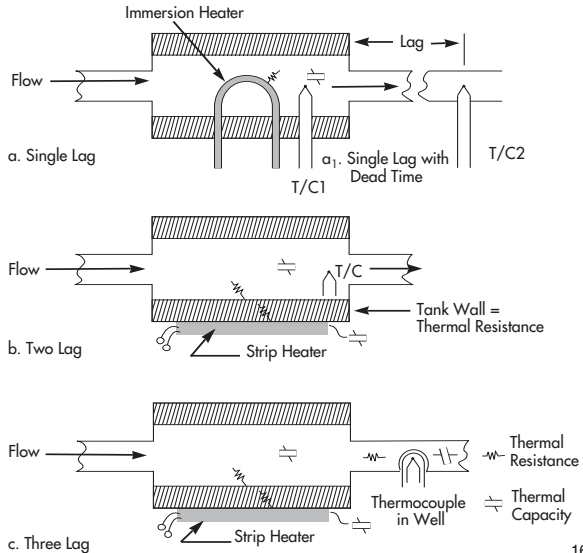

Tuning Procedures











For best results in tuning the temperature controller, the setpoint value should be at least 100° F above or below ambient temperature.

While some processes other than heat or cool applications may respond successfully to autotuning procedures, the controller must be manually tuned for most non-temperature processes.

Introduction

The Series 16 is an “on demand” autotuning controller that automatically sets PID parameter values (Proportional Band, Reset and Rate) before the process reaches setpoint. A damping setting (menu level “02”) MUST be selected for autotuning to take place. (see *Notes on Damping*, page 19). The controller may also be tuned manually (see page 20).











Autotuning the Series 16 Temperature Controller

- 1) With the power off and the process at ambient, apply power and immediately put the controller in Standby mode by holding the  key for four seconds until [StbY] flashes in the lower display window.
- 2) Enter the desired Setpoint Value using the appropriate Raise  or Lower  key. [StbY] will continue to flash.
- 3) If controller is in menu level “00” or “01”, hold the Parameter/ Access  key for 11 seconds until [Ac.Cd] appears. Then change to menu level “05”. Otherwise, press the  key once and use the  key to select menu level “05”.
- 4) Press the Parameter/Access  key twice until [SnSr] is displayed to make sure that the proper sensor has been selected. Then set the controller’s heating mode or alarm functions by pressing the Parameter/Access  key again until [OUT1] is displayed. (If you scroll past it, just continue scrolling until the parameter menu repeats.) Using the appropriate Raise  or Lower  key, select the one of the following settings according to the requirements of your process. *Note: For autotuning, at least one output MUST be set to PID mode.*

Mode	Output 1 (Heat) Setting	Output 2 (Cool) Setting
PID	[Ht.P]	[CL.P]
On/Off	[Ht.O]	[CL.O]
Alarm	[ALr]	[ALr]

Press the Parameter/Access  key again to step to output 2 [OUT2]. Repeat the selection process for cooling mode or alarm. **(If only one output is PID, set the other output to either On/Off or Alarm.)**

Tuning Procedures

- 5) Press the Parameter/Access  key again to display the Cooling Type parameter [CoL.t], and select either Normal/Linear output [nor] or Water-Cooled/Non-Linear output [H2o].
- 6) Exit menu level “05” by pressing the Mode  key once. The lower window will flash [StbY]. Now press the Parameter/Access  key once. The lower window will display [Ac.Cd] and [05]. Press the Lower  key twice to select menu level “03”.
- 7) Press the Parameter/Access  key and select Cycle Time for Output 1 [CY.t1] and Cycle Time for Output 2 [CY.t2]. For Control Output type B, T or Y, enter “15”. For Control Output type E, F or S, enter “00”.
- 8) Press the Parameter/Access key until Setpoint Target Time [SP.tt] is displayed. Select [OFF].
- 9) Press the Mode  key once. The lower window will again flash [StbY]. Press the Parameter/Access  key once and the lower window will display [Ac.Cd] and [03]. Press the Lower  key once to select menu level “02”.
- 10) Press the Parameter/Access  key and scroll through the displayed parameters. If Gain Ratio [Gr.o2] is displayed, set it to [1.0]. Otherwise, continue scrolling until [dPnG] appears. Set Damping initially to Normal [nL]. (This setting may have to be changed later).
- 11) Press and hold the Mode  key until [tUnE] flashes in the lower display window. The controller is now autotuning. When it stops flashing, the autotuning procedure is completed and the controller is ready for your process. As a security measure, you may wish to place the controller in Key Lock “00” or Limited Access “01” Run mode by changing menu levels as instructed previously.

Note: Re-tune controller only from ambient temperature. Autotuning will not function when process is at setpoint.

Tuning Procedures

Before autotuning can take place, you must select a damping setting. If the damping parameter does not appear on the menu, you have not selected a PID option for outputs 1 or 2. Refer back to step (4) and select the proper setting(s).

During autotuning, the process temperature will gradually cycle from ambient to setpoint. When autotuning is complete, the [tUnE] display will stop flashing and the Gain, Rate and Reset numbers "learned" will be kept in memory for subsequent startups.

Figure 13. Typical "Autotune" Temperature Profile.

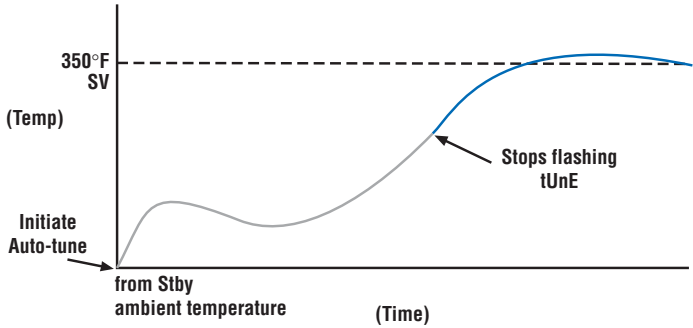

Tuning Procedures





If overcooling exists on heat/cool processes after autotuning, decrease Gain Ratio [Gr.o2] in steps of 0.1 until oscillation is minimal. If cooling is sluggish, increase the value in steps of 0.1 until optimum results are achieved.

Gain ratio [Gr.o2] is the cooling gain expressed as a factor of the heating gain.

*Ex. [Gn.01] = 100
Cooling Gain = 50
[Gr.o2] = .5*

Manual Tuning Procedure - Temperature Controller (Zeigler-Nichols PID Method)

This tuning method may be used if the spread between ambient temperature and process operating temperature is small. For best results, the use of a recording device is suggested when tuning with this method.

- 1) Disable any cooling device used.
- 2) Apply power and place the controller in Standby by pressing and holding the Mode  key for four seconds.
- 3) Using Raise  or Lower  key, adjust setpoint to desired value.
- 4) Access menu level "02" following instructions given previously.
- 5) Using the Parameter/Access  key, index to Heat Gain [Gn.o1]. Select [01].
- 6) Index to Gain Ratio [Gr.o2] and select [1.0].
- 7) Index to Rate [rAtE] and select [00].
- 8) Index to Reset [rSEt] and select [00]. Note: In order to set Reset to [00], Rate must first be set to [00].
- 9) Change to menu level "03".
- 10) Index to Cycle Time 1 [CY.t1] and select the timebase, in seconds, appropriate to the device being controlled.

Tuning Procedures

- 11) Repeat for Cycle Time 2 [CY.t2].
- 12) Change to menu level "05".
- 13) Set Cooling Type [CoL.t] to [nor].
- 14) Press the Mode \equiv key once. Setpoint Value will be displayed. The recording device should now be tracking process temperature.
- 15) Double the Gain [Gn.o1] until a small, sustained oscillation is visible on the recording device's trace.
- 16) Measure the period of one cycle of oscillation ("T" on the diagram below).

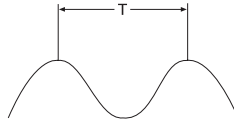

- 17) Divide the period of oscillation (T) by eight (8). The resulting number is the correct Rate time [rAtE] in seconds. Multiply this number by four. This is the correct Reset time [rSEt] in seconds.
- 18) Multiply the gain (from step #15) by 0.6 and enter this number as Gain [Gn.o1].
- 19) Enable the cooling device. If overcooling exists, decrease the Gain Ratio [Gr.o2] in steps of 0.1 until temperature oscillation stops. If cooling is sluggish, increase the Gain Ratio in steps of 0.1 until optimum results are achieved.

Tuning Procedures

Calculate and enter these numbers:

Rate [rAtE] = $T/8$

Reset [rSEt] = $T/2$

Gain [Gn.01] = Gain from Step (6)

On noisy processes, where Rate cannot be used:

Gain [Gn.01] = from Step (6) $\times 0.45$

Reset [rSEt] = $T/1.2$

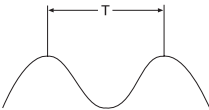

Special Functions

In manual control mode, error conditions such as A/D errors and open or reversed sensors will be ignored.

Manual Tuning Procedure - Process Controller (Zeigler-Nichols PID Method)

A chart recorder to monitor the process variable is required. The controller must be properly scaled and filtering set as instructed previously.

- 1) Apply power and place the controller in Standby by holding the Mode \equiv key for four seconds.
- 2) Adjust the setpoint to the desired value.
- 3) Access menu level "05" and select one output: [OUT 1] for reverse-acting control or [OUT 2] for direct-acting control. Set the active output to PID [Pid] and the unused output to Alarm [ALr] or On/Off [On.F].
- 4) Access menu level "02" and set [Gn.01] to 1.0; [Gr.o2] to 1.0; and [rAtE] and [rSEt] to "00".
- 5) Press the Mode \equiv key for four seconds until display flashes [tUnE]. Press the Mode key for another four seconds and the process will run in closed loop mode.
- 6) While monitoring the chart, increase Gain [Gn.o1] by doubling the gain number until the process variable becomes unstable. Then decrease Gain until the process oscillations are sustained, neither increasing nor decreasing in amplitude as a result of momentary setpoint change.
- 7) Multiply the Gain from Step (6) by 0.6.
- 8) Measure the period of one complete cycle of oscillation, "T", in seconds.

Auto/Manual Operation (Standard)

To put the controller in manual mode, set the damping [dPnG] parameter in menu level "02" to [OFF]. Press and hold the Mode \equiv key for four seconds until the lower display window flashes [StbY]. Hold down the Mode key for another four seconds to initiate manual operation. The lower display window will flash percentage of output power, from 100 to -100, alternating with the output controlled (temperature controllers will flash [HEAt] or [Cool], process controllers will flash [OUT1] or [OUT2].) To take the controller out of manual mode, press and hold Mode \equiv key to four seconds.

Note: The Series 16 controller can only be ordered with one of the following Special Functions installed per instrument.

Remote Setpoint Select

If your Series 16 controller was ordered with this option, you may select either of two setpoints for your process. The second setpoint can be enabled only by an external switch or signal, according to your ordering specifications. The "F2" LED on the front panel will illuminate when a second setpoint is selected. If you do not know how your Series 16 was configured, refer to the ordering code and description on page 39.

Special Functions

Option Part #	Description
40	External switch wired to terminals 6 and 7 Switch Open: Normal operation, first setpoint enabled Switch Closed: Second setpoint enabled Setpoint Adjustments: Made from front panel
41	External switch wired to terminals 6 and 7 Switch Closed: Normal operation, first setpoint enabled Switch Open: Second setpoint enabled Setpoint Adjustments: Made from front panel
42	0-5 Vdc signal at pins 6 and 7 0 Vdc: First setpoint enabled 5 Vdc: Second setpoint enabled Setpoint Adjustments: Made from front panel

Maximum Input Impedance: 400 ohms @ +5 Vdc , 5 mA

Figure 14. Wiring Diagram for Remote Setpoint Select Option

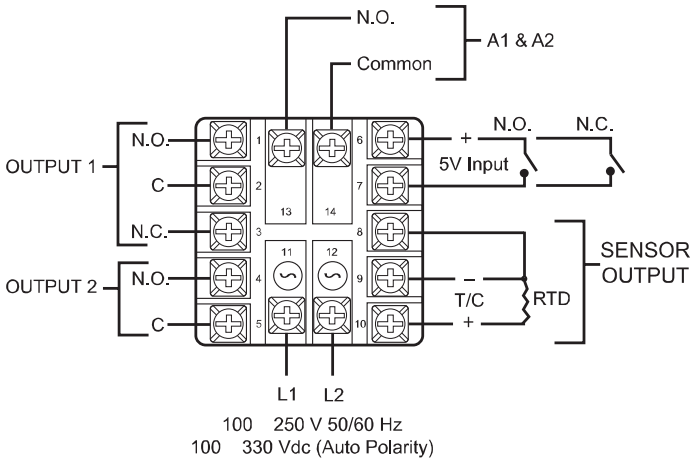

Special Functions

These output values are linear with and dependent upon the sensor being used, i.e., the lowest value of the sensor's output range corresponds to zero or low for the output function.

For voltage output, a jumper must be installed between terminals 13 and 14.

Process Variable Retransmission

If your Series 16 controller was ordered with this option, you may retransmit the signal representing the process variable for analysis or storage to an external device that accepts analog input, such as a chart recorder, datalogger, or process control computer. These outputs are:

Suppressed: 1-5 Vdc/4-20 mAdc

Unsuppressed: 0-5 Vdc/0-20 mAdc

Process Variable Retransmission Specifications

I_{out} (current output) = 0-20 mA/4-20 mA
 Voltage Headroom = 8 Vdc (standard) 18 Vdc
 (for multiple recording devices)
 V_{out} (voltage output) = 0-5Vdc/1-5 Vdc
 I_{out} Max = 20 mA

Figure 15. Wiring Diagram for Process Variable Retransmission

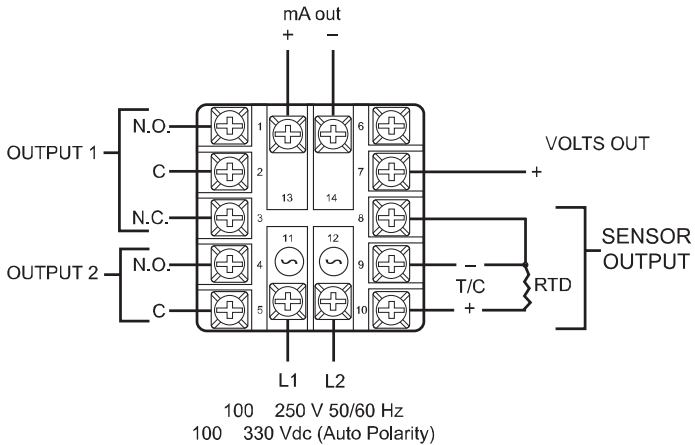

Special Functions

The Heater Break Alarm option is not available on controllers with an "F" type output.

With the Heater Break Alarm option, cycle time is limited to greater than 2 seconds.

Heater Break Alarm (Series 16 Temperature Controller)

The heater break alarm option detects failures in the load or power handler and provides an alarm output. It uses an external current transformer to monitor the load current. If the load current falls below a set current value, the alarm output is activated.

With this option, a heater current reading [Ht.rd] from a current transformer is displayed at menu level "04", along with the preset Heater Current Alarm Setpoint Value [Ht.SP], either 00-30 A or 00-60 A.

Current Transformer Specifications

.29 Dia. Opening

INDICATING RANGE: 2 thru 100 A

MAX. CONT. CURRENT: 100 A

MAX. TRANSIENT CURRENT: 150 A for 5 sec.

WORKING CLASS: 600 • **FREQUENCY:** 50-60 Hz

WEIGHT: .5 Oz (14 grams)

LEAD WIRE: #22 AWG UL Style 1213

CASE COLOR: Black • **CASE MATERIAL:** Thermoplastic

Figure 16. Current Transformer Supplied with Heater Break Alarm Option, Part # 580E023UOI

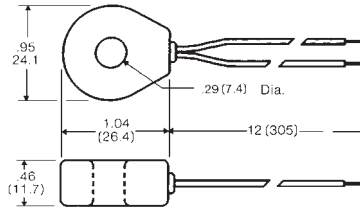
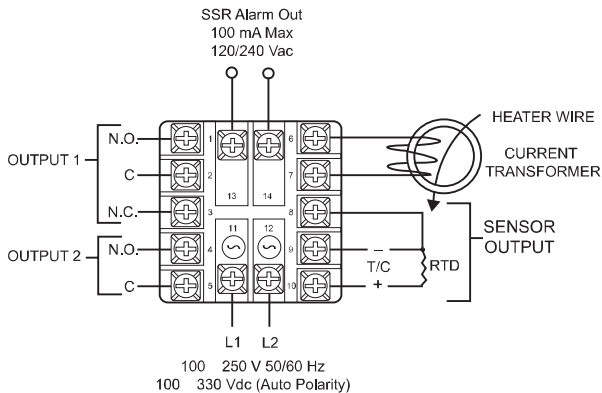

Figure 17. Wiring Diagram for Heater Break Alarm



Special Functions

Transducer Excitation

The transducer excitation voltage option is used to produce a constant dc voltage of 10, 12 or 15 Vdc out to an external device, eliminating the need for an additional external power supply. Refer to the ordering code if you do not know which voltage output was specified.

Option Ordering Code	Voltage Output
50	10 V
51	12 V
52	15 V
53	5 V

Maximum Current = 22 mA

Figure 18. Wire Diagram for 2-Wire Sensor Input with Transducer Excitation Option

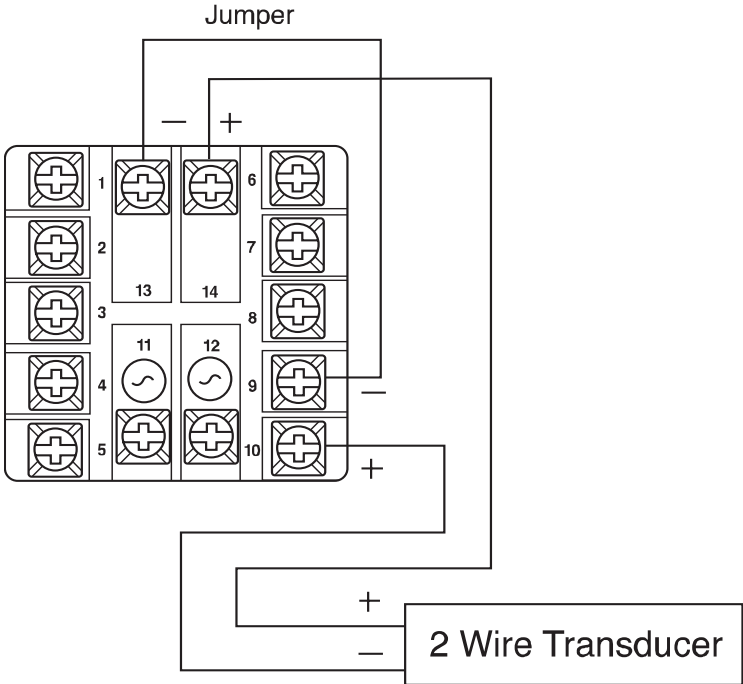

Digital Communications

Two communication options are available for the Series 16 which allow interfacing to remote devices utilizing the most common industry standards, RS232 and RS485.

WARNING

Signal ground only. Grounding to frame may damage the controller and void warranty.

RS232

This method allows bidirectional data transfer via a three-conductor cable consisting of signal ground, receive input and transmit output. It is recommended for communication distances less than fifty feet between the computer terminal and the instrument. Note: Multiple instruments cannot be connected to the same port.

The RS232 port is optically isolated to eliminate ground loop problems. Typically, "Data Out" of the computer/terminal connects to the "RCV" terminal. "Data In" connects to the "XMT" terminal. If shielded cable is used, it should be connected to the frame ground at one end only. Signal ground is to be connected at appropriate ground terminals (refer to wiring diagram, page 28).

RS485

The RS485 multipoint capability allows up to 32 controllers to be connected together in a half-duplex network or up to 100 controllers with an appropriate communications repeater. This method allows bidirectional data transfer over a shielded twisted pair cable. The twisted pair cable is a transmission line; therefore, terminating resistors are required at the most distant ends of the line to minimize reflections (typically 60 ohms from each line to signal ground). The RS485 circuit is fully optically isolated, eliminating ground loop problems. Parallel drops from the transmission lines should be kept as

Digital Communications

Note: Call factory for a recommended RS485 converter.

short as possible; however, the line may be daisy-chained at each controller. The polarity of the line is important and each device will specify an "A" (+) and "B" (-) connection.

Figure 19. Wiring diagram for digital communications.

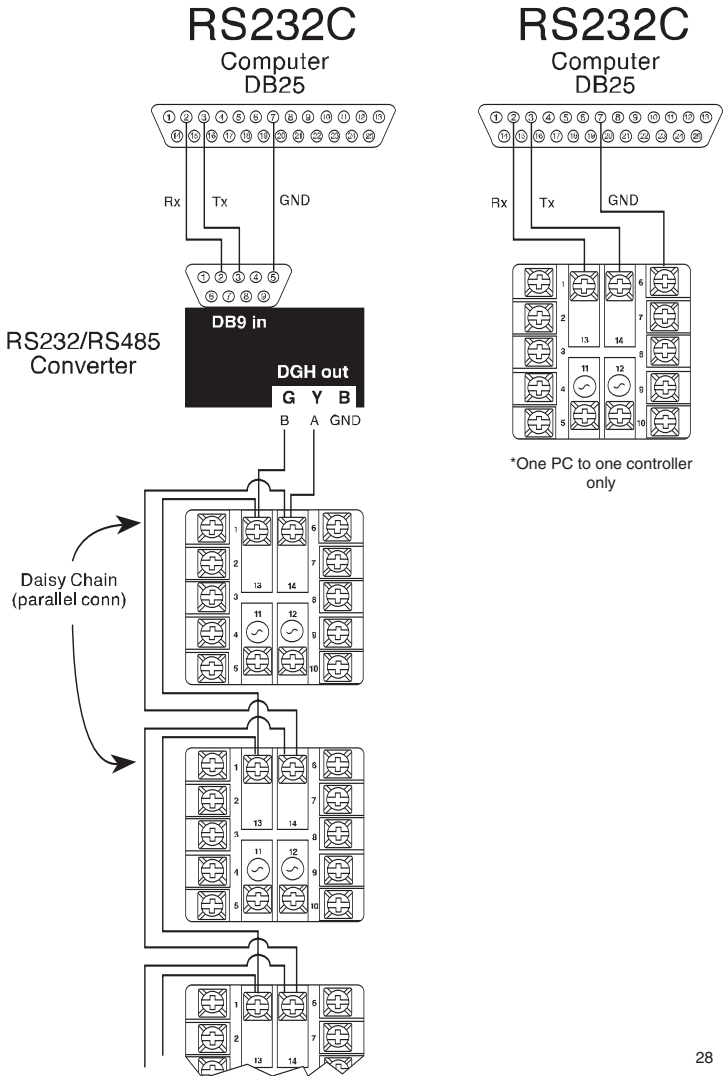

Digital Communications

**Table 1. Communications Parameter List
(Temperature Controller)**

Parameter No.	Description	Display	Minimum	Maximum
00	Process Value	nnnn	Sensor Dependent	
01	Setpoint	nnnn	Low Limit	High Limit
02	Access Code	Ac.Cd	00	05
03	Gain Output 1	Gn.o1	00	400
04	Gain Ratio 2	Gr.o2	0.0	2.0
05	Rate	rAtE	00	900
06	Reset	rSEt	00	3600
07	Heat Hysteresis	H.HYS	01	100
08	Cool Hysteresis	C.HYS	01	100
09	Cool Spread	C.SPPr	00	100
10	Damping	dPnG	00	Low/Normal/High
11	Alarm 1	ALr1	Range Dependent	
12	Alarm 2	ALr2	Range Dependent	
13	Cycle Time 1	CY:t1	00	120
14	Cycle Time 2	CY:t2	00	120
15	Setpoint Target Time	Sp.tt	00 (OFF)	100
16	Low Setpoint Limit	L.SP.L	Sensor Dependent	
17	High Setpoint Limit	U.SP.L	Sensor Dependent	
18	Controller ID	Id.no	00	99
19	Baud Rate	bAUd	300	2400

**Table 2. Communications Parameter List
(Process Controller)**

Parameter No.	Description	Display	Minimum	Maximum
00	Process Value	nnnn	Low Scale	High Scale
01	Setpoint	nnnn	Low Scale	High Scale
02	Access Code	Ac.Cd	00	05
03	Gain Output 1	Gn.o1	00	400
04	Gain Ratio 2	Gr.o2	0.0	2.0
05	Rate	rAtE	00	900
06	Reset	rSEt	00	3600
07	Hysteresis 1	HYS.1	01	100
08	Hysteresis 2	HYS.2	01	100
09	Spread 2	SPr.2	00	100
10	Damping	dPnG	00	Low/Normal/High
11	Alarm 1	ALr1	Low Scale	High Scale
12	Alarm 2	ALr2	Low Scale	High Scale
13	Cycle Time 1	CY:t1	00	120
14	Cycle Time 2	CY:t2	00	120
15	Setpoint Target Time	Sp.tt	00 (OFF)	100
16	Low Scale	L.SCL	-1999	9999
17	High Scale	H.SCL	-1999	9999
18	Controller ID	Id.no	00	99
19	Baud Rate	bAUd	300	2400

Table 3. Serial Communications Data Format

Baud Code	Baud Rate	Parity	Data Bits	Stop Bits
0	300	Odd	7	2
1	600	Odd	7	2
2	1200	Odd	7	2
3	2400	Odd	7	2
4	300	None	8	1
5	600	None	8	1
6	1200	None	8	1
7	2400	None	8	1

Interface Examples

This section describes the protocol for communication between an Series 16 controller and either a video display terminal or computer (referred to below as “the host”). Message strings may be of two types — commands to controller or responses from controller.

General Comments

One host and multiple controllers may be interconnected on a single bus. The host may send commands to any controller and may receive responses from any controller. Each controller on the bus is assigned an identification code between 00 and 99. No two controllers on a given bus may have the same identification code. Controllers are not capable of communicating with other controllers.

Every valid message begins with a pound-sign (#) character.

Every valid message ends with a carriage-return (<CR>) character.

A valid message is composed of: Start Message, Controller ID Code, Command, Parameter and Data.

Every response begins with a line-feed (<LF>) character and ends with a carriage-return, line-feed pair (<CRLF>).

*Caution:
Modifying parameter #19 (Baud Rate) by host may cause
loss of data link.*

Figure 20. General Communications Message Format

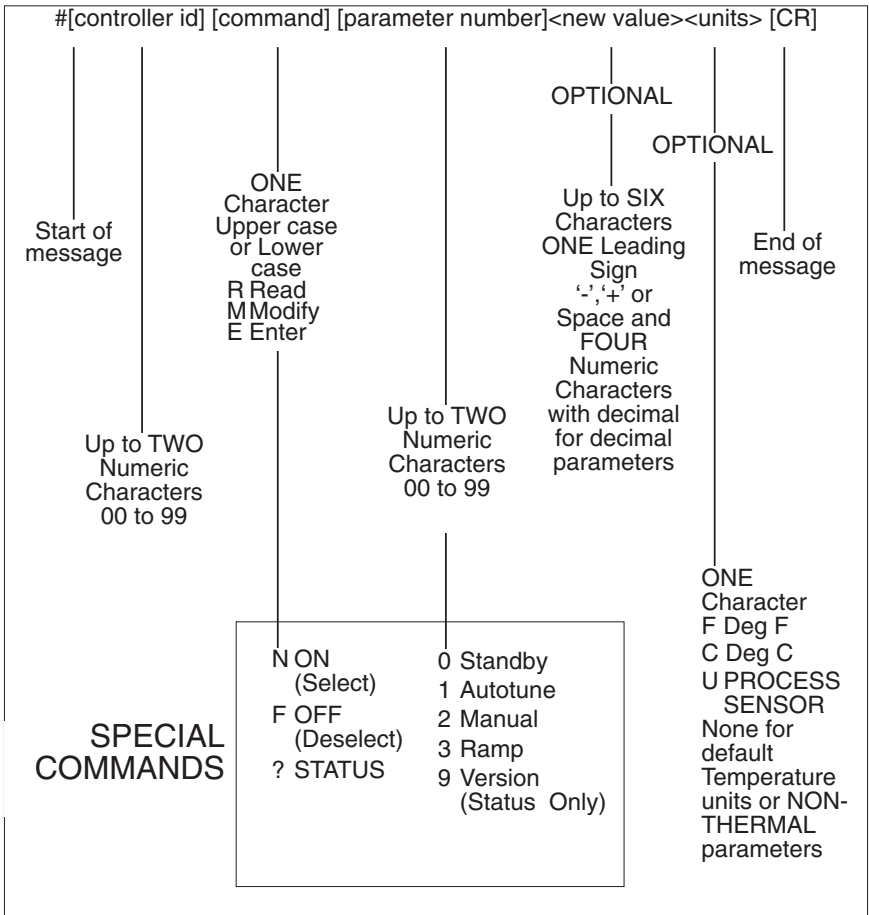

Example: For Standby "On", type #01N0[CR].

Figure 21. Sample Communications Commands

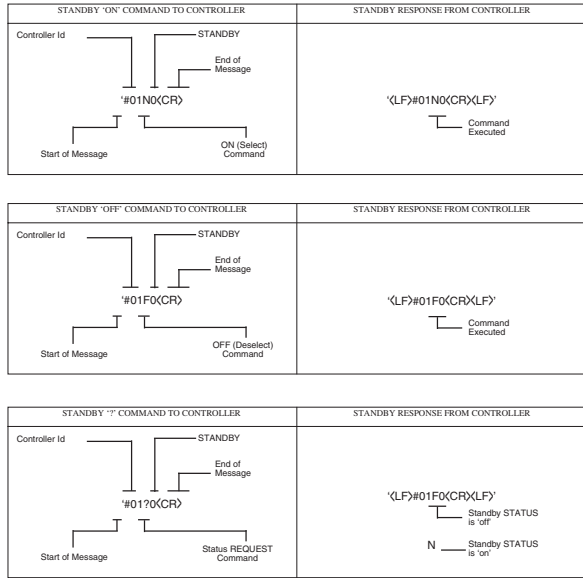
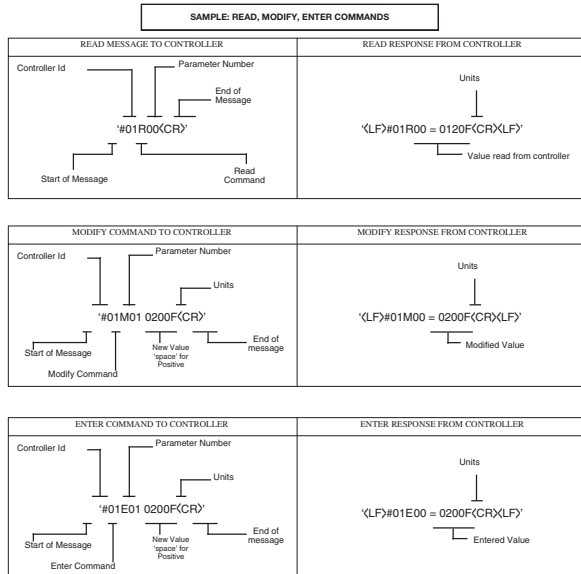

Figure 22. Requesting a Parameter from a Controller



Communications

Notes

Caution:







Wherever possible, avoid using the “Enter” command and use “Modify” or “Read” instead. The “Enter” command makes permanent changes to the NOVRAM in the Series 16’s microprocessor, and after accepting a maximum capacity of 100,000 “Enter” statements, it will have to be returned to the factory and replaced.

1. The controller will respond with <LF>ERROR<CR><LF> for messages containing invalid/incorrect commands, parameter number or data (with decimal, if needed).
2. Process Value is a read-only parameter; therefore, a modify or enter command for Process Value will result in a <LF>ERROR<CR><LF> response.
3. For modify or enter command: if the new value is out of the parameter’s range, the controller will default to the highest or lowest allowable parameter value.
4. Parameters with decimal data must contain a decimal character in the data portion of the message.
5. Ramp “on” command (Setpoint Target Time) will not be executed if ramp time is set to zero or absolute deviation between Setpoint and Process Value is less than or greater than 5 temperature or process units.
6. Autotune, manual and ramp commands are mutually exclusive, i.e., selecting manual while autotune is enabled will abort the autotune mode.
7. If the controller is in Standby mode, selecting autotune, manual or ramp will de-select Standby.
8. Setpoint should not be modified while the controller is in autotune or ramp mode.
9. The Setpoint Value enter command should not be executed while the controller is in manual mode.

Recalibration

Only qualified individuals utilizing the appropriate calibration equipment should attempt recalibration of the controller. For assistance, contact your Athena representative or call 1-800-782-6776.

Your Series 16 has been calibrated at the factory, and need not be adjusted during the life of the controller unless sensor type is changed from thermocouple to RTD, or vice versa. In the event that recalibration is warranted, follow these procedures.

- 1) Access menu level "05" as previously instructed and select the sensor type.
- 2) Use a calibrator with a range appropriate for the unit to be calibrated and set the range, and a low or zero value.
- 3) Access menu level "04" and then the Parameter/Access  key until [CAL.L] is displayed. Then, press the Raise  or Lower  key until the number in the controller's upper (PV) display window matches the indicated value of the calibration instrument.
- 4) Enter a value on the calibration instrument corresponding with the high-end value of the sensor range (span).
- 5) Again, in menu level "04", press the Parameter/Access  key until [CAL.H] is displayed. Then, press the Raise  or Lower  key until the number in the controller's upper (PV) display window matches the indicated value of the calibration instrument.
- 6) Repeat steps 3 through 5 until all readings agree.
- 7) Return the controller to regular operation by pressing the Mode  key.

Error Codes

Display	Problem	Action
[Err.H]	Open sensor	Check sensor and wiring Check type of sensor Recalibrate
[Err.L]	Reversed sensor	Check sensor and wiring Check type of sensor Recalibrate
[Err.O]	A/D error	Return to factory
[Err.J]	A/D error	Return to factory
- - -	Display out-of-range	Sensor over- or under-range

Warranty/Repair Information

Two-Year Limited Warranty

Other than those expressly stated herein, THERE ARE NO OTHER WARRANTIES OF ANY KIND, EXPRESS OR IMPLIED, AND SPECIFICALLY EXCLUDED BUT NOT BY WAY OF LIMITATION, ARE THE IMPLIED WARRANTIES OF FITNESS FOR A PARTICULAR PURPOSE AND MERCHANTABILITY.

IT IS UNDERSTOOD AND AGREED THE SELLER'S LIABILITY WHETHER IN CONTRACT, IN TORT, UNDER ANY WARRANTY, IN NEGLIGENCE OR OTHERWISE SHALL NOT EXCEED THE RETURN OF THE AMOUNT OF THE PURCHASE PRICE PAID BY THE PURCHASER AND UNDER NO CIRCUMSTANCES SHALL SELLER BE LIABLE FOR SPECIAL, INDIRECT, INCIDENTAL OR CONSEQUENTIAL DAMAGES. THE PRICE STATED FOR THE EQUIPMENT IS A CONSIDERATION IN LIMITING SELLER'S LIABILITY. NO ACTION, REGARDLESS OF FORM, ARISING OUT OF THE TRANSACTIONS OF THIS AGREEMENT MAY BE BROUGHT BY PURCHASER MORE THAN ONE YEAR AFTER THE CAUSE OF ACTION HAS ACCRUED.

SELLER'S MAXIMUM LIABILITY SHALL NOT EXCEED AND BUYER'S REMEDY IS LIMITED TO EITHER (i) REPAIR OR REPLACEMENT OF THE DEFECTIVE PART OR PRODUCT, OR AT SELLER'S OPTION (ii) RETURN OF THE PRODUCT AND REFUND OF THE PURCHASE PRICE, AND SUCH REMEDY SHALL BE BUYER'S ENTIRE AND EXCLUSIVE REMEDY.

Unit Repairs

It is recommended that units requiring service be returned to an authorized service center. Before a controller is returned for service, please consult the service center nearest you. In many cases, the problem can be cleared up over the telephone. When the unit needs to be returned, the service center will ask for a detailed explanation of problems encountered and a Purchase Order to cover any charge. This information should also be put in the box with the unit. This should expedite return of the unit to you.

This document is based on information available at the time of its publication. While efforts have been made to render accuracy to its content, the information contained herein does not cover all details or variations in hardware, nor does it provide for every possible contingency in connection with installation and maintenance. Features may be described herein which are not present in all hardware. Athena Controls assumes no obligation of notice to holders of this document with respect to changes subsequently made.

Proprietary information of Athena Controls, Inc. is furnished for customer use only. No other use is authorized without the written permission of Athena Controls, Inc.

Technical Specifications

Performance

Accuracy	±0.2% of full scale, ± one digit
Setpoint Accuracy	1 degree/0.1 degree
Temperature Stability	5 µV/°C max; 3 µV/°C typical
TC Cold End Tracking	0.05° C/°C ambient
Noise Rejection	Common mode >100 dB Series Mode >70 dB
Process Sampling Rate	10 Hz (100 ms)

Inputs

Thermocouple	K, J, N, R, T, S, Maximum lead resistance 100 ohms for rated accuracy
RTD	Platinum 2- and 3-wire, 100 ohms at 0° C, DIN curve standard (0.00385)
Linear	0-50 mV/10-50 mV, 0-5 V/1-5 V 0-20 mA/4-20 mA

Input Impedances

0-50 mV/10-50 mV:	1 K ohm ± 1%
0-5/1-5 V:	100 K ohms ± 1%
0-20 mA/4-20 mA:	2.5 ohms ± 1%
0-10 V/2-10 V:	200 K ohms

Technical Specifications

Outputs

#1	Reverse acting (heating or alarm)
#2	Direct acting (cooling or alarm)
B	Relay, 5 A @ 120 Vac resistive 3 A @ 240 Vac
E	0-20 mAdc
F	4-20 mAdc, 500 ohms max.
S	20 Vdc pulsed
T	Solid-state relay, 120/240 Vac, zero voltage-switched, 1 A continuous, 10 A surge
@ 25° C	
Y (Output 2 only)	N.C. Relay, 5 A @ 120 Vac resistive 3 A @ 240 Vac

Alarms

Vac,	Electromechanical relay, 5 A @ 120 3 A @ 240 Vac (Output 1 <u>OR</u> 2 only)
surge	Dual-Alarm option: Two solid-state relays, 120/240 Vac, zero voltage- switched, 1 A continuous, 10 A @ 25°C

Control Characteristics

Setpoint Limits	Limited to configured range
Alarms	Adjustable for high/low; selectable process or deviation
Rate	0 to 900 seconds
Reset	0 to 3600 seconds
Cycle Time	0.2 (zero setting) to 120 seconds

Technical Specifications

Gain	0 to 400
Gain Ratio	0 to 2.0 (in 0.1 increments)
Control Hysteresis	1 to 100 units (on/off configuration)
Cool Spread, Output 2 (Temperature Controller)	0 to 100° F/C (above setpoint)
Spread 2, Output 2 (Process Controller)	0 to 100 units (above setpoint)
Damping	Selectable (low, normal, high, off)
Setpoint Target Time (Ramp-to-Setpoint)	0 (off) to 100 minutes
Autotune	Operator-initiated from front panel
Manual	Operator-initiated from front panel

General

Line Voltage	115 to 230 V \pm 10%, 50-60 Hz 115 to 300 Vdc \pm 10% (Auto-Polarity)
Display	Dual, 4-digit 0.36" (9.2 mm) LED display Process Value: Orange Setpoint Value/Menu: Green
Power Consumption	Less than 6 VA (@ 120/240 Vac)
Panel Cutout	1.771" x 1.771" (45 mm x 45 mm)
Depth Behind Panel	3.937" (100 mm)
Front Panel Rating	NEMA 4X
Operating Temperature	32 to 131° F (0 to 55° C)
Humidity Conditions	90% R.H. max., non-condensing
Parameter Retention	Solid-state, non-volatile memory
Connections	Input and output via barrier strip with locking terminals
Contacts	Twin bifurcated

Ordering Codes

Model 16

Input	Range	Code
"K" TC	0 to 2460° F	KF
"K" TC	-18 to 1349° C	KC
"J" TC	0 to 1400° F	JF
"J" TC	-18 to 760° C	JC
"N" TC	0 to 2370° F	NF
"N" TC	-18 to 1299° C	NC
"R" TC	0 to 3200° F	RF
"R" TC	-18 to 1760° C	RC
"T" TC	-200 to 600° F	TF
"T" TC	-129 to 316° C	TC
"S" TC	0 to 3200° F	SF
"S" TC	-18 to 1760° C	SC
Platinel II	0 to 2372° F	LF
Platinel II	-18 to 1300° C	LC
100 ohm RTD	-328 to 1562° F	PF
100 ohm RTD	-200 to 850° C	PC
100 ohm RTD	-199.0 to 450.0 ° F	DF
100 ohm RTD	-128.8 to 232.2° CDC	
1 to 5 V	Scaleable	L1
10 to 50 mV	Scaleable	L2
4 to 20 mA *	Scaleable	L3
0 to 5 V	Scaleable	L4
0 to 50 mV	Scaleable	L5
0 to 20 mA*	Scaleable	L6
0 to 10 V	Scalable	L7
2 to 10 V	Scalable	L8
0 to 1V	Scalable	L9

Output 1

Code

0 = None
 B = Relay
 F = 4-20 mA
 S = Pulsed 20 Vdc
 T = S.S. Relay
 E = 0-20 mA

Output 2

Code

0 = None
 B = Relay
 F = 4-20 mA
 S = Pulsed 20 Vdc
 T = S.S. Relay
 E = 0-20 mA
 Y = N.C.
 Mechanical Relay
 Contacts Output #2
 Only

Options

Standard Options
 00 = None

Dual Alarms

10 = S.S. Relay
 20 = Floating Transistor
 Open Collector Switch
 21 = 24 Vdc drive
 22 = S.S. Relay - N.C.

Communications

30 = RS-232
 31 = RS-485

Remote Setpoint Select (w/ alarm)

40 = Switch Close
 41 = Switch Open
 42 = 5 volt Input

Transducer Excitation

50 = 10 Vdc
 51 = 12 Vdc
 52 = 15 Vdc

Process Variable Retransmit Signal

60 = 4-20 mA
 61 = 1-5 Vdc
 62 = 0-20 mA
 63 = 0-5 Vdc

Heater Break Alarm

70 = 5-30 Amps
 71 = 10-60 Amps

Special Options -
 See List
 If NONE: Enter 00
 (Consult Factory)

Keep This Information in a Safe Place

Configured Parameters Reference Card

Series 16/18/19/25 Temperature Controllers

Model Number _____

Zone Location _____

Firmware Version No. _____



(Displayed when the controller is powered up after all the segments on both lines of the display have been tested.)

Dear Customer:

Please keep this information handy – in case your controller should lose its configured initial parameter values or for easy reference when setting up a new controller. After auto-tuning, and when your controller is controlling well, we suggest you write the displayed value for each of the menu parameters below. If you do not use a listed parameter, indicate “N/A”. Using this information to document your parameter settings could reduce your downtime. If you have any questions, or need further assistance, please contact Athena Controls Technical Support:

Toll-free (in USA): 800.782.6776

Telephone: 610.828.2490

Fax: 610.828.7084

E-Mail: techsupport@athenacontrols.com

Website: athenacontrols.com

Configured Parameters Reference Information

Series 16/18/19/25 Temperature Controllers

Menu 2

Gn.01 _____

Gn.02 _____

rAtE _____

rSEt _____

dPnG _____

H.HYS _____

C.HYS _____

C.SP_r _____

Menu 3

Alr1 _____

Alr 2 _____

CY.t _____

CY.t2 _____

SP.tt _____

L.SP.L _____

U.SP.L _____

Menu 4

Id.no _____

bAUd _____

Menu 5

SnSr _____

FLt _____

OUt1 _____

OUt2 _____

CoL.t _____

Al.HL _____

Al.Pd _____

Al.OP _____

A2.HL _____

A2.Pd _____

A2.OP _____

Unit _____



Keep This Information in a Safe Place

Configured Parameters Reference Card

Series 16/18/19/25 Temperature Controllers

Model Number _____

Zone Location _____

Firmware Version No. _____



(Displayed when the controller is powered up after all the segments on both lines of the display have been tested.)

Dear Customer:

Please keep this information handy – in case your controller should lose its configured initial parameter values or for easy reference when setting up a new controller. After auto-tuning, and when your controller is controlling well, we suggest you write the displayed value for each of the menu parameters below. If you do not use a listed parameter, indicate "N/A". Using this information to document your parameter settings could reduce your downtime. If you have any questions, or need further assistance, please contact Athena Controls Technical Support:

Toll-free (in USA): 800.782.6776

Telephone: 610.828.2490

Fax: 610.828.7084

E-Mail: techsupport@athenacontrols.com

Website: athenacontrols.com

Configured Parameters Reference Information

Series 16/18/19/25 Temperature Controllers

Menu 2

Gn.O1 _____

Gn.O2 _____

rAbE _____

rSEt _____

dPnG _____

H.HYS _____

C.HYS _____

C.SP_r _____

Menu 3

RI_r1 _____

RI_r 2 _____

CY.t _____

CY.t2 _____

SP.tt _____

L.SP.L _____

U.SP.L _____

Menu 4

Id.no _____

bAUd _____

Menu 5

SnSr _____

FLt _____

OUt1 _____

Unit2 _____

CoL.t _____

RI.HL _____

RI.Pd _____

RI.OP _____

R2.HL _____

R2.Pd _____

R2.OP _____

Unit _____



***For technical assistance, call toll free
1-800-782-6776 (in the U.S.) or 610-828-
2490 (from anywhere in the world), or
e-mail techsupport@athenacontrols.com.***



Athena Controls, Inc.
5145 Campus Drive
Plymouth Meeting, PA 19462 USA
Toll-free: 800.782.6776
Tel: 610.828.2490
Fax: 610.828.7084
techsupport@athenacontrols.com
athenacontrols.com